



Thorax  
Thorax  
Thorax  
Tórax  
Torace

Rippenscheren  
Rib Shears  
Costotomes  
Costótomos  
Costotomi

**ASH** INSTRUMENTS

SURGICAL INSTRUMENTS



**56102.23**  
23,0 cm



**56105.22**  
22,0 cm

Rippenschere mit ziehendem Schnitt  
Rib shears with drawing cut  
Costotome avec lame excentrée  
Costótomo con hoja de retroacción  
Costotomo con lama eccentrica a scorrimento



**GLUCK**  
**56107.22**  
22,0 cm



**STILLE**  
**56111.21**  
21,0 cm



CORYLLOS  
**56125.35**  
35,0 cm

CORYLLOS  
**56123.35**  
35,0 cm



BETHUNE  
**56126.34**  
34,0 cm

Rippenscheren  
Rib Shears  
Costotomes  
Costótomos  
Costotomi

**ASH** INSTRUMENTS

SURGICAL INSTRUMENTS



**COOLEY**  
**56128.35**  
35,0 cm



**SAUERBRUCH**  
**56131.26**  
26,0 cm

für die erste Rippe  
for the first rib  
pour la première côte  
para la primera costilla  
per la prima costola



**GIERTZ-STILLE**  
**56137.27**  
27,0 cm



**SAUERBRUCH-FREY**  
**56141.36**  
36,0 cm



**BRUNNER**  
**56147.28**  
32,0 cm

für die rechte Hand  
for right hand  
pour la main droite  
para la mano derecha  
per la mano destra

**BRUNNER**  
**56149.28**  
32,0 cm

für die linke Hand  
for left hand  
pour la main gauche  
para la mano  
izquierda  
per la mano sinistra

Sternum Schere  
Sternum scissors  
Ciseaux a sternum  
Tijera de esternón  
Forbici per sterno



**SCHUMACHER**  
**56148.21**  
21,0 cm

Blatt · Blade · valve · hoja · valva		
Spreizung Spread	Tiefe Depth	Breite Width
Ecartement	profondité	largeur
Abertura	profundidad	ancho
Apertura	profondità	larghezza
A	B	C



### FINOCHIETTO

	A = mm	B = mm	C = mm
<b>56210.16</b>	165 mm	40 mm	40 mm
<b>56210.20</b>	200 mm	45 mm	65 mm
<b>56210.25</b>	250 mm	70 mm	65 mm
<b>56210.30</b>	300 mm	70 mm	65 mm

für Erwachsene · for adults · pour adultes · para adultos · per adulti

### ALUMINIUM



### FINOCHIETTO (modif.)

	A = mm	B = mm	C = mm
<b>56212.12</b>	120 mm	14 mm	15 mm

für Kinder · for children · pour enfants · para niños · per bambini



Blatt · Blade · valve · hoja · valva		
Spreizung Spread Ecartement Abertura Apertura	Tiefe Depth profondité profundidad profondità	Breite Width largeur ancho larghezza
A	B	C



### FINOCHIETTO-BABY

	A = mm	B = mm	C = mm
<b>56214.75</b>	75 mm	18 mm	20 mm

für Säuglinge · for babies · pour bébé · para bebés · per neonati

### ALUMINIUM



### COOLEY

	A = mm	B = mm	C = mm
<b>56220.01</b>	95 mm	12 mm	13 mm

für Säuglinge · for babies · pour bébé · para bebés · per neonati

### COOLEY

	A = mm	B = mm	C = mm
<b>56220.02</b>	140 mm	15 mm	30 mm
<b>56220.03</b>	150 mm	21 mm	44 mm

für Kinder · for children · pour enfants · para niños · per bambini

### COOLEY

	A = mm	B = mm	C = mm
<b>56220.04</b>	200 mm	35 mm	50 mm

für Erwachsene · for adults · pour adultes · para adultos · per adulti

Blatt · Blade · valve · hoja · valva		
Spreizung Spread Ecartement Abertura Apertura	Tiefe Depth profondité profundidad profondità	Breite Width largeur ancho larghezza
A	B	C

ALUMINIUM



FINOCHIETTO

	A = mm	B = mm	C = mm
<b>56230.13</b>	135 mm	38 mm	44 mm
<b>56230.17</b>	175 mm	52 mm	62 mm
<b>56230.18</b>	175 mm	85 mm	65 mm

für Erwachsene · for adults · pour adultes · para adultos · per adulti

ALUMINIUM



FINOCHIETTO HAIGHT Baby

	A = mm	B = mm	C = mm
<b>56232.10</b>	100 mm	31 mm	31 mm

für Kinder · for children · pour enfants · para niños · per bambini

Blatt · Blade · valve · hoja · valva		
Spreizung Spread Ecartement Abertura Apertura	Tiefe Depth profondité profundidad profondità	Breite Width largeur ancho larghezza
A	B	C

ALUMINIUM



FINOCHIETTO

	A = mm	B = mm	C = mm
<b>56234.40</b>	100 mm	12 mm	15 mm
<b>56234.41</b>	143 mm	28 mm	30 mm
<b>56234.42</b>	210 mm	31 mm	45 mm
<b>56234.43</b>	245 mm	42 mm	61 mm
<b>56234.44</b>	245 mm	74 mm	64 mm

für Erwachsene · for adults · pour adultes · para adultos · per adulti

Blatt · Blade · valve · hoja · valva		
Spreizung Spread	Tiefe Depth	Breite Width
Ecartement	profondité	largeur
Abertura	profundidad	ancho
Apertura	profondità	larghezza
A	B	C

ALUMINIUM



FINOCHIETTO Infant

	A = mm	B = mm	C = mm
<b>56234.75</b>	75 mm	15 mm	15 mm

für Säuglinge · for babies · pour bébé · para bebés · per neonati



mit 2 Paar Valven  
 with 2 pairs of blades  
 avec 2 paires de valves  
 con 2 pares de valvas  
 con 2 paia di valve

FINOCHIETTO BURFORD

	A = mm	B = mm	C = mm
<b>56236.21</b>	210 mm	48/77 mm	64 mm
<b>56236.25</b>	260 mm	48/77 mm	64 mm
<b>56236.30</b>	300 mm	48/77 mm	64 mm

für Erwachsene · for adults · pour adultes · para adultos · per adulti

Blatt · Blade · valve · hoja · valva		
Spreizung Spread Ecartement Abertura Apertura	Tiefe Depth profondité profundidad profondità	Breite Width largeur ancho larghezza
A	B	C



ALUMINIUM

mit 2 Paar Valven  
 with 2 pairs of blades  
 avec 2 paires de valves  
 con 2 pares de valvas  
 con 2 paia di valve

FINOCHIETTO BURFORD

	A = mm	B = mm	C = mm
<b>56242.18</b>	180 mm	47/65 mm	62 mm
<b>56242.26</b>	260 mm	47/65 mm	62 mm
<b>56242.30</b>	300 mm	47/65 mm	62 mm

für Erwachsene · for adults · pour adultes · para adultos · per adulti



Blatt · Blade · valve · hoja · valva		
Spreizung Spread	Tiefe Depth	Breite Width
Ecartement	profondité	largeur
Abertura	profundidad	ancho
Apertura	profondità	larghezza
A	B	C

mit 2 Paar Valven  
 with 2 pairs of blades  
 avec 2 paires de valves  
 con 2 pares de valvas  
 con 2 paia di valve

**FINOCHIETTO BURFORD**

	A = mm	B = mm	C = mm
<b>56244.13</b>	135 mm	34/48 mm	42 mm

für Kinder · for children · pour enfants · para niños · per bambini



**CASTAÑEDA**

	A = mm	B = mm	C = mm
<b>56250.06</b>	65 mm	10,5 mm	32 mm

für Säuglinge · for babies · pour bébé · para bebés · per neonati

**CASTAÑEDA**

	A = mm	B = mm	C = mm
<b>56250.07</b>	70 mm	12 mm	45 mm

für Kinder · for children · pour enfants · para niños · per bambini

**CASTAÑEDA**

	A = mm	B = mm	C = mm
<b>56250.12</b>	120 mm	15 mm	60 mm

für Kinder · for children · pour enfants · para niños · per bambini

Blatt · Blade · valve · hoja · valva		
Spreizung Spread	Tiefe Depth	Breite Width
Ecartement	profondité	largeur
Abertura	profundidad	ancho
Apertura	profondità	larghezza
A	B	C



CHEVALIER

	A = mm	B = mm	C = mm
<b>56259.19</b>	190 mm	27 mm	100 mm



HAIGHT

	A = mm	B = mm	C = mm
<b>56260.09</b>	90 mm	30 mm	30 mm
<b>56260.15</b>	115 mm	30 mm	30 mm



Blatt · Blade · valve · hoja · valva		
Spreizung Spread	Tiefe Depth	Breite Width
Ecartement	profondité	largeur
Abertura Apertura	profundidad profondità	ancho larghezza
A	B	C

### TUFFIER

	A = mm	B = mm	C = mm
<b>56264.16</b>	165 mm	50 mm	45 mm



Thoraxsperrer  
 Thoracic retractor  
 Ecarteur thoracique  
 Separador torácico  
 Divaricatore per il torace



### MERCEDES 56.270.00

Thoraxsperrer, komplett, bestehend aus:

- 56.270.10** 1 Sperrer
- 56.270.48** 2 Seitenvalven 42 x 65 mm
- 56.270.70** 2 Seitenvalven 75 x 75 mm

Thoracic retractor, complete, consisting of:

- 56.270.10** 1 Spreader
- 56.270.48** 2 Lateral blades 42 x 65 mm
- 56.270.70** 2 Lateral blades 75 x 75 mm

Ecarteur thoracique, complet, compuesto de:

- 56.270.10** 1 Ecarteur
- 56.270.48** 2 Valves latérales 42 x 65 mm
- 56.270.70** 2 Valves latérales 75 x 75 mm

Separador torácico, completo, compuesto de:

- 56.270.10** 1 Separador
- 56.270.48** 2 Valvas laterales 42 x 65 mm
- 56.270.70** 2 Valvas laterales 75 x 75 mm

Divaricatore per il torace, completo, composto da:

- 56.270.10** 1 Divaricatore
- 56.270.48** 2 Valve laterali 42 x 65 mm
- 56.270.70** 2 Valve laterali 75 x 75 mm



Blatt · Blade · valve · hoja · valva		
Spreizung Spread Ecartement Abertura Apertura	Tiefe Depth profondité profundidad profondità	Breite Width largeur ancho larghezza
A	B	C



### MORSE-FAVOLORO

	A = mm	B = mm	C = mm
<b>56273.16</b>	160 mm	17 mm	22 mm

für Kinder · for children · pour enfants · para niños · per bambini

### MORSE-FAVOLORO

	A = mm	B = mm	C = mm
<b>56273.19</b>	200 mm	22 mm	27 mm

für Erwachsene · for adults · pour adultes · para adultos · per adulti



### HERTZLER

	A = mm	B = mm	C = mm
<b>56278.00</b>	105 mm	25 mm	25 mm

Rippensperrer und -Kontraktor  
mit drehbaren Klauen

Rib spreader and contractor  
with swivel blades

Ecarteur et rapprocheur des côtes  
avec valves orientables

Separador y contractor costal  
con garras girables

Divaricatore ed approssimatore costale  
con valve orientabili

für Kinder  
for children  
pour enfants;  
para niños  
per bambini

für Erwachsene  
for adults  
pour adultes  
para adultos  
per adulti



**SELLORS**  
**56280.19**  
19,0 cm



**BAILEY-BABY**  
**56282.14**  
15,5 cm



**BAILEY**  
**56284.16**  
20,0 cm



**BAILEY-GIBBON**  
**56286.16**  
20,0 cm

Lunge  
Lung  
Poumon  
Pulmón  
Polmone

Lungenspatel  
Lung Spatulas  
Spatule pulmonaire  
Espátula para el pulmón  
Spatole per polmone



cm	<b>ALLISON</b>
25,5	<b>56289.30</b>
32,0	<b>56289.32</b>

Lungenfaßzangen  
Lung Grasping Forceps  
Pincés à saisir le poumon  
Pinzas para coger el pulmón  
Pinze per afferrare il polmone



<b>LOVELACE</b>
<b>56290.20</b>
20,0 cm



<b>LOVELACE</b>
<b>56291.20</b>
20,0 cm

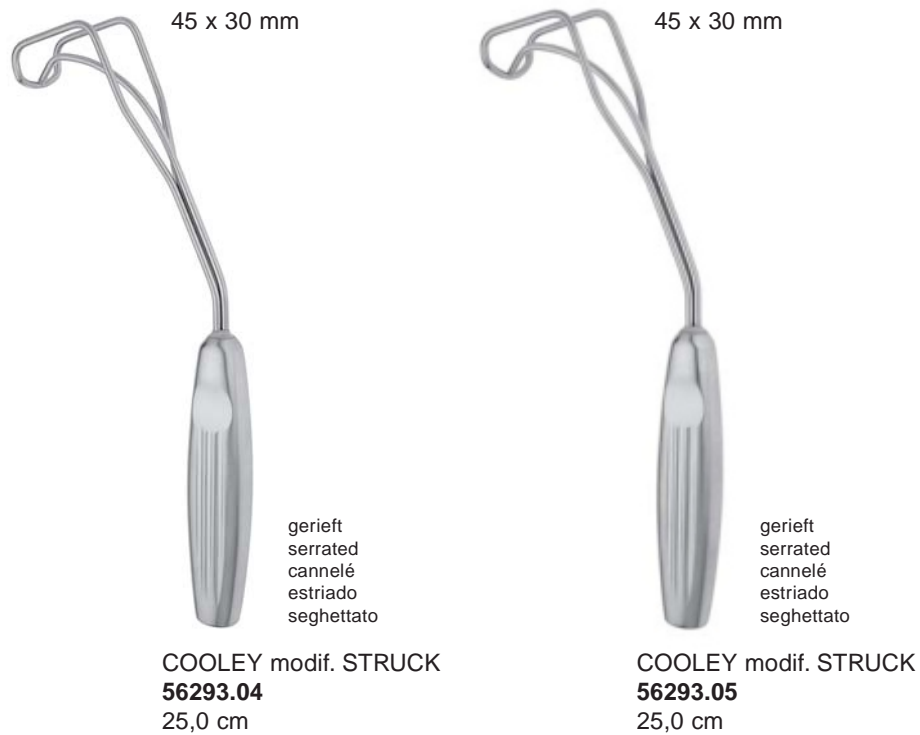
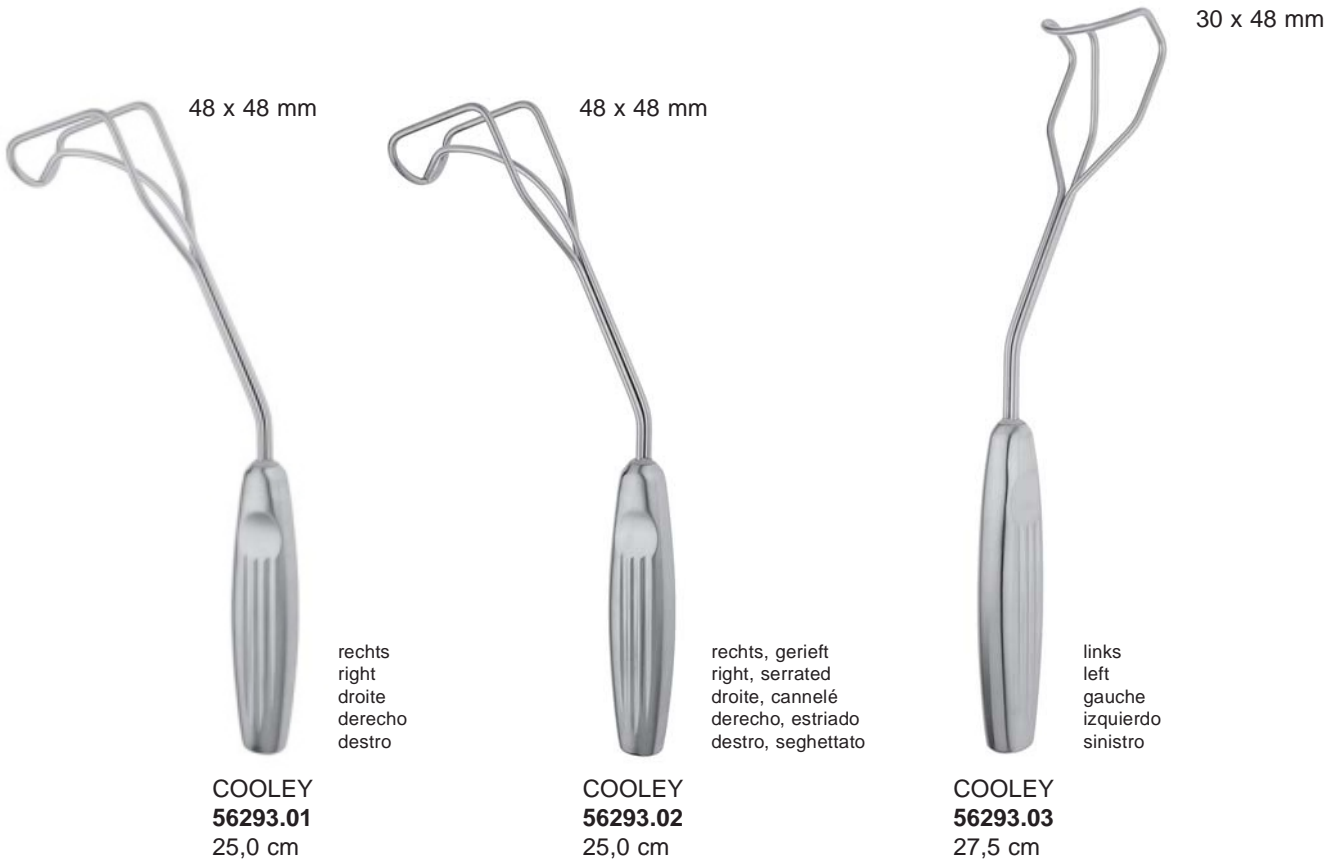

Bronchusklemmen  
Bronchus Forceps  
Pincers-Clamps à Bronches  
Pinzas clamps bronquiales  
Pinze per bronchi



HARRINGTON  
**56301.30**  
30,5 cm



cm HARRINGTON  
29,0 **56303.29**  
31,0 **56303.31**



FINOCHIETTO  
**56307.24**  
24,0 cm

Bronchusklemmen  
Bronchus Forceps  
Pinces-Clamps à Bronches  
Pinzas clamps bronquiales  
Pinze per bronchi



PRICE-THOMAS  
**56309.22**  
22,0 cm



links  
left  
à gauche  
izquierda  
sinistra

PRICE-THOMAS  
**56311.22**  
22,0 cm



rechts  
right  
à droite  
derecha  
destra

PRICE-THOMAS  
**56313.22**  
22,0 cm

Bronchusklemmen  
Bronchus Forceps  
Pincés-Clamps à Bronches  
Pinzas clamps bronquiales  
Pinze per bronchi



SAROT  
**56317.23**  
23,0 cm



SAROT  
**56319.23**  
23,0 cm



SAROT



SEMB  
**56321.23**  
23,0 cm

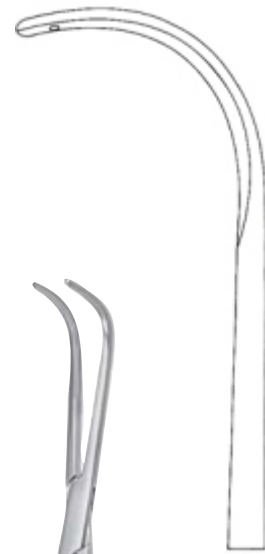

SEMB  
**56323.23**  
23,0 cm

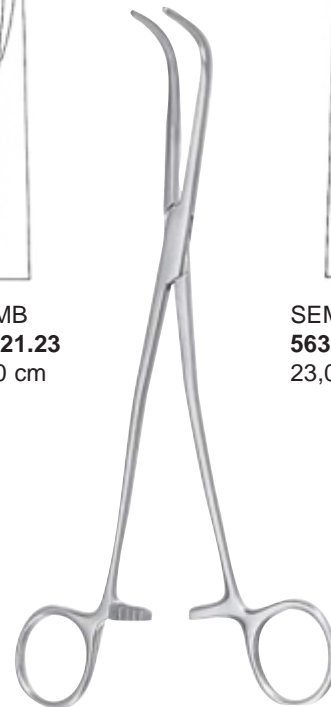

SEMB

Anastomosen- (Vena cava) Klemmen  
Anastomosis (Vena Cava) Clamps  
Pinces-clamps à anastomose (veine cave)  
Pinzas clamps para anastomosis (vena cava)  
Pinze per anastomosi (vena cava)



SATINSKY  
**56325.15**  
15,0 cm



SATINSKY



**56327.26**  
Fig. 1  
26,5 cm

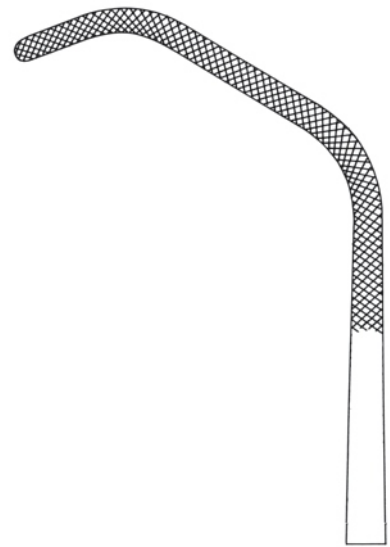

**56329.26**  
Fig. 2  
26,5 cm



Anastomosen- (Vena cava) Klemmen  
Anastomosis (Vena Cava) Clamps  
Pinces-clamps à anastomose (veine cave)  
Pinzas clamps para anastomosis (vena cava)  
Pinze per anastomosi (vena cava)



SATINSKY

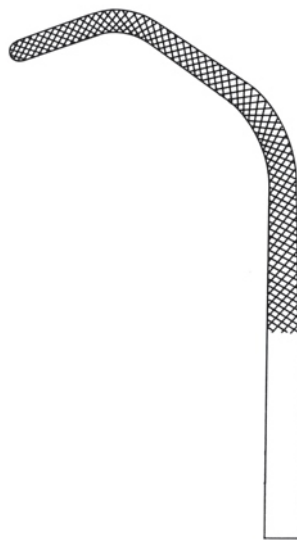

**56331.26**  
Fig. 1  
26,5 cm

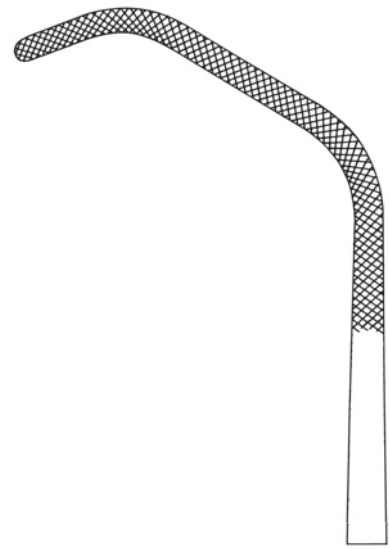

**56333.26**  
Fig. 2  
26,5 cm



**BROCK**  
**56410.00**

Griff allein  
 Handle only  
 Manche seul  
 Mango suelto  
 Manico solo



**BROCK**  
**56412.00**

Dilatator Spreizweite 8 - 20 mm  
 Dilator Opening 8 to 20 mm  
 Dilatateur ouverture 8 à 20 mm  
 Dilatador abertura 8 a 20 mm  
 Dilatore apertura 8 a 20 mm

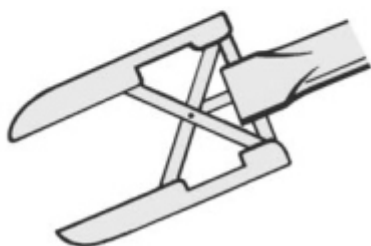

∅ mm	BROCK
4,0	<b>56414.04</b>
7,5	<b>56414.07</b>
10,0	<b>56414.10</b>
12,0	<b>56414.12</b>

Stanzen  
 Punches  
 Pincas coupantes  
 Pinzas cortantes  
 Pinze taglianti

Herz-Dilatatoren  
Mitral Valve Dilators  
Dilatateurs pour valve mitrale  
Dilatadores para válvula mitral  
Dilatatori per valvole mitrali

**ASH** INSTRUMENTS

SURGICAL INSTRUMENTS

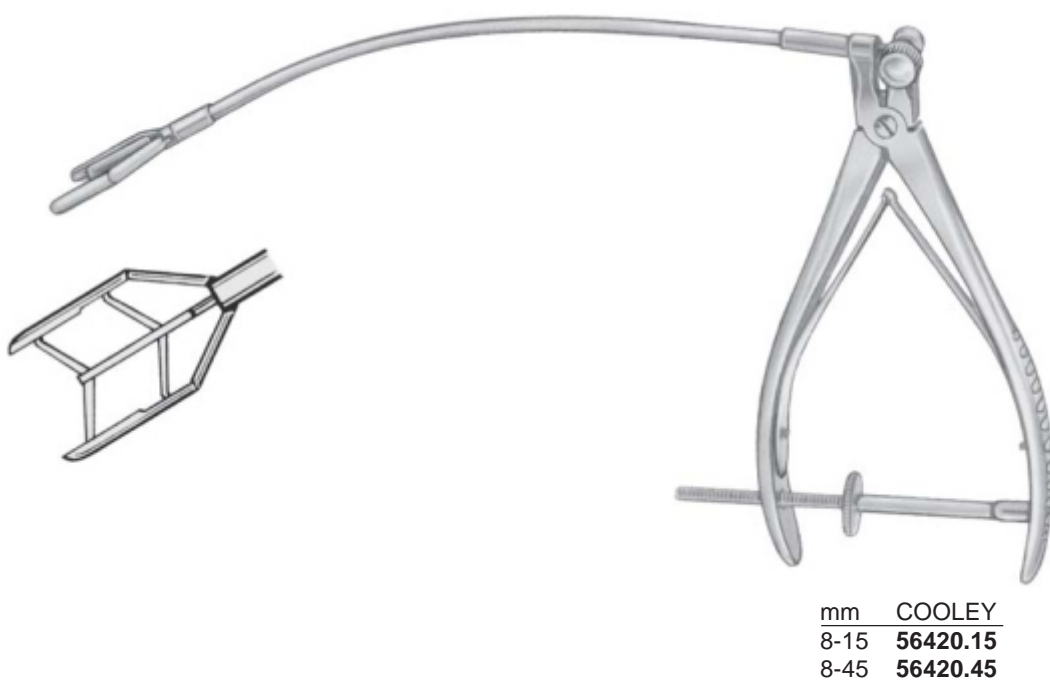
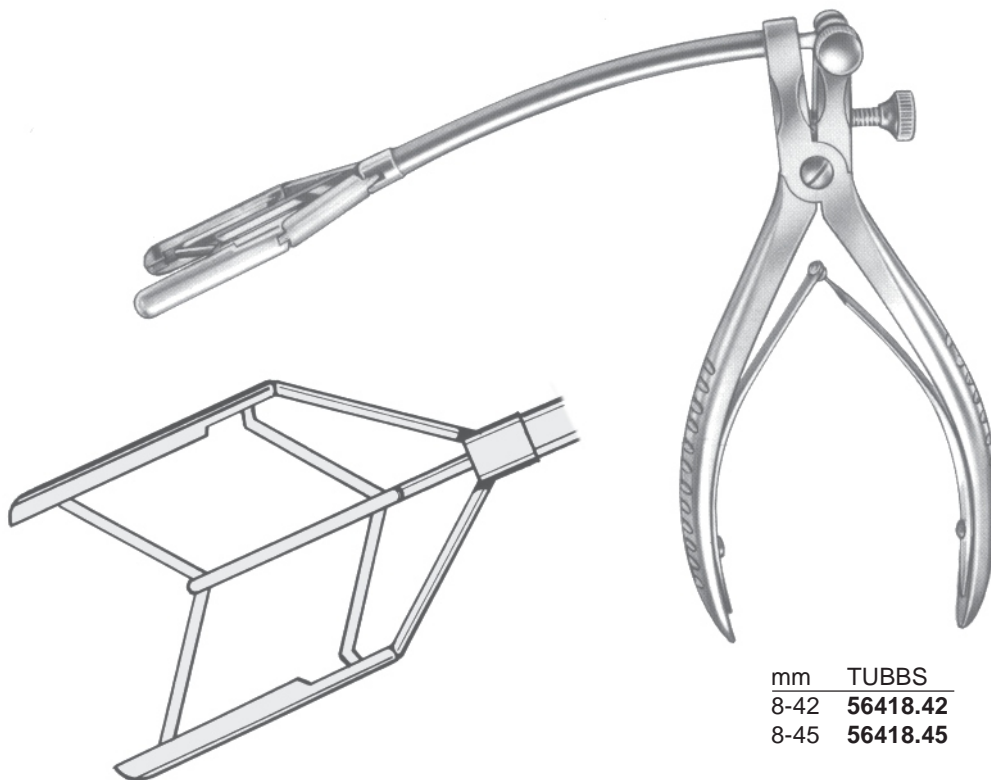

Herz-Dilatatoren  
Mitral Valve Dilators  
Dilateurs pour valve mitrale  
Dilatadores para válvula mitral  
Dilatatori per valvole mitrali

**ASH** INSTRUMENTS

SURGICAL INSTRUMENTS

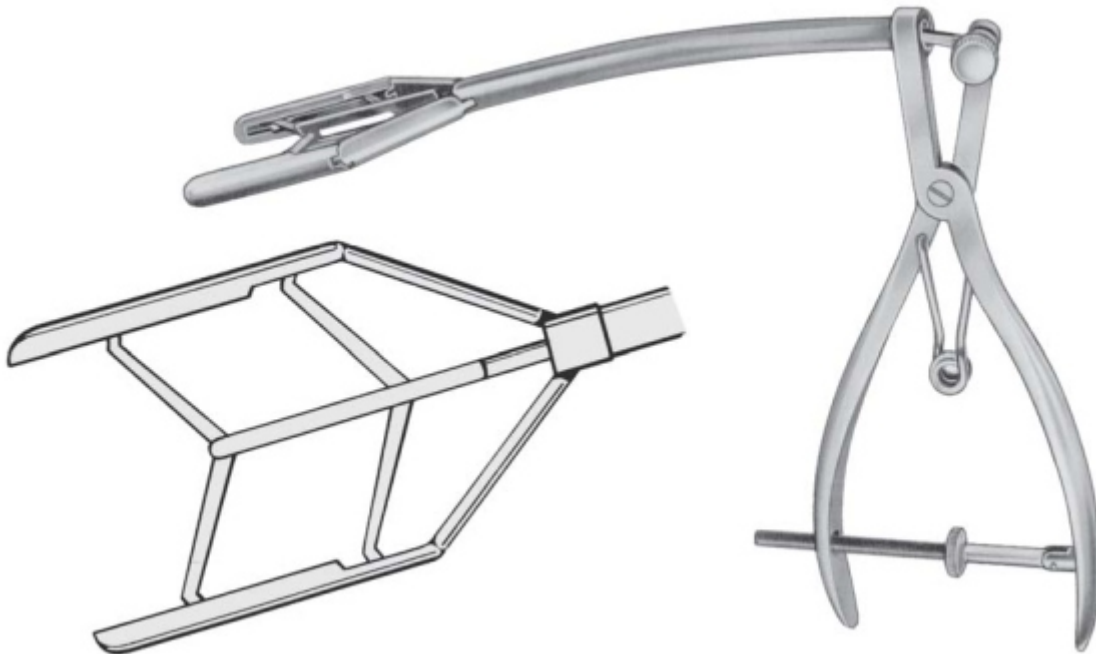

mm GERBODE  
9-45 56422.45

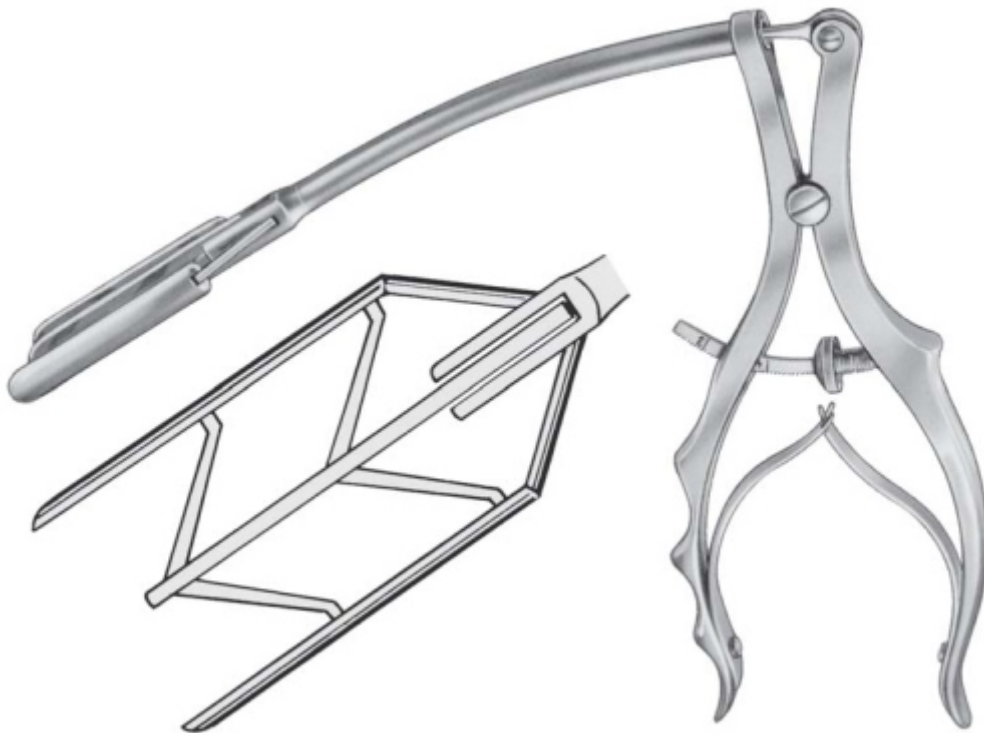

mm COOLEY  
7-30 56423.30  
9-40 56423.40

Herz-Dilatatoren  
Mitral Valve Dilators  
Dilatateurs pour valve mitrale  
Dilatadores para válvula mitral  
Dilatatori per valvole mitrali

**ASH** INSTRUMENTS

SURGICAL INSTRUMENTS



mm COOLEY  
5-18 **56425.18**  
6-20 **56425.20**



mm HETZER  
4-10 **56426.10**

biegsam, Silber  
malleable, silver  
malléables, argent  
maleables, silver  
maleabili, argento

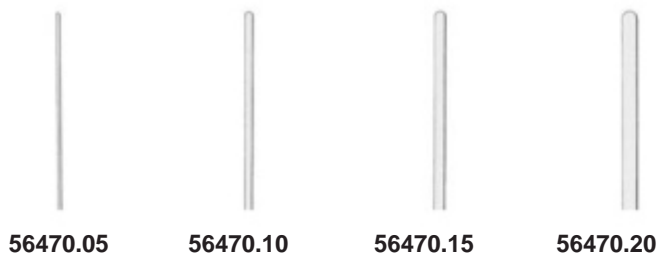

56470.05

56470.10

56470.15

56470.20

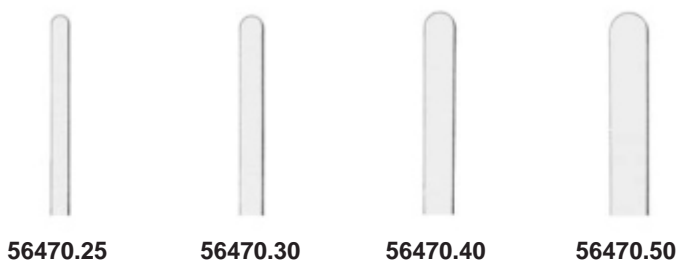

56470.25

56470.30

56470.40

56470.50

COOLEY	
ø mm	13,0 cm
0,5	<b>56470.05</b>
1,0	<b>56470.10</b>
1,5	<b>56470.15</b>
2,0	<b>56470.20</b>
2,5	<b>56470.25</b>
3,0	<b>56470.30</b>
4,0	<b>56470.40</b>
5,0	<b>56470.50</b>

biegsam  
 malleable  
 malléables  
 maleables  
 maleabili

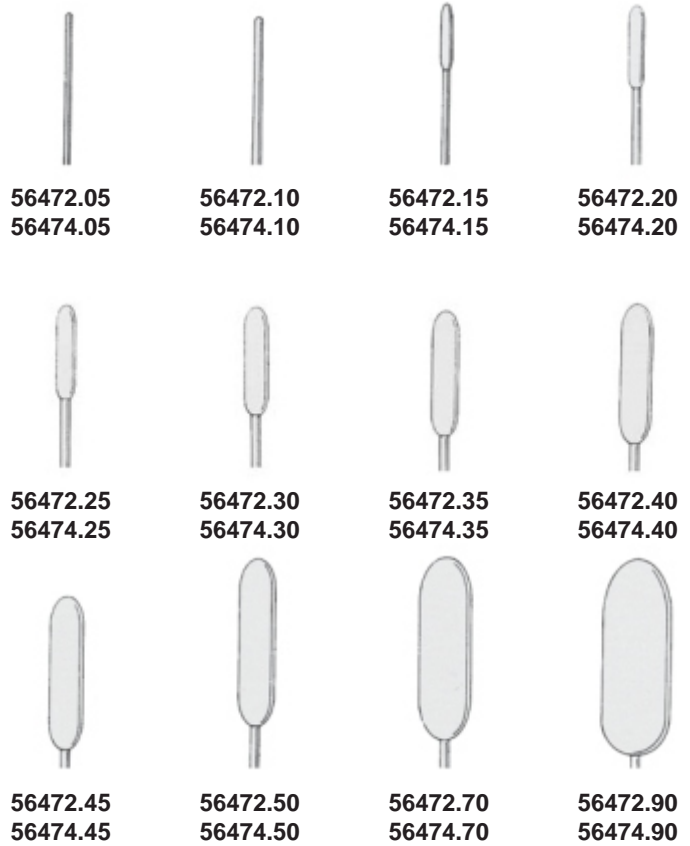

DEBAKEY

ø mm	19,0 cm	35,0 cm
0,5	56472.05	56474.05
1,0	56472.10	56474.10
1,5	56472.15	56474.15
2,0	56472.20	56474.20
2,5	56472.25	56474.25
3,0	56472.30	56474.30
3,5	56472.35	56474.35
4,0	56472.40	56474.40
4,5	56472.45	56474.45
5,0	56472.50	56474.50
7,0	56472.70	56474.70
9,0	56472.90	56474.90

Intima-Spatel  
Intima spatula  
Spatule pour la tunique interne  
Espátula para la íntima  
Spatola per intima

**ASH** INSTRUMENTS

SURGICAL INSTRUMENTS



cm  
18,0 **56505.18**  
21,0 **56505.21**

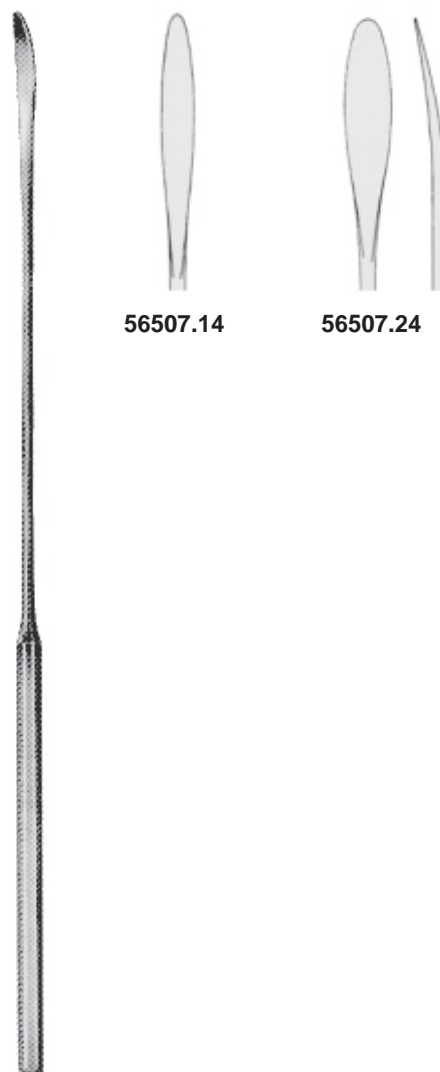

**56507.14**

**56507.24**

cm 3 mm  
14,0 **56507.14**  
24,0 **56507.24**



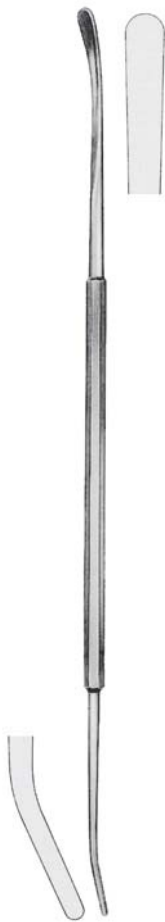

ROBB  
**56509.01**  
Fig. 1  
24,0 cm



ROBB  
**56509.02**  
Fig. 2  
24,0 cm



ROBB  
**56509.03**  
Fig. 3  
24,0 cm

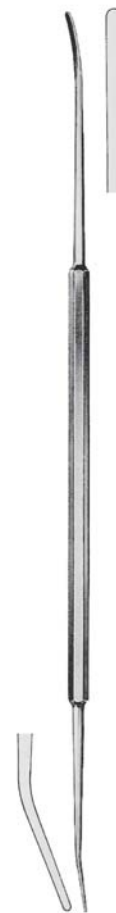

ROBB  
**56509.04**  
Fig. 4  
24,0 cm

